

Aerogen® Solo

System Instruction Manual



Contents

Introduction	1
Indications for Use	2
System Warnings	4
Assembly & Installation	6
Installation For Use With A Ventilator	11
Installation For Use With Non-Invasive Ventilation	15
Optimum Use	16
Installation For Use Off-Ventilator	17
Nebulization Modes	23
Functional Test	27
Aerogen Solo Aerosol Flow Rate Calculation	28
Troubleshooting	29
Warranty	31
Life Of Product	31
Specifications	32
Performance	33
Symbols Glossary	35
Appendix 1	36
Appendix 1: EMC Tables	39

Introduction

The Aerogen® Solo System is an iteration of the Aerogen® Pro Nebulizer System. The indications for use of the Aerogen® Solo Nebulizer System are given below. The Aerogen® Solo System consists of the Aerogen® Solo nebulizer and the Aerogen® Pro-X Controller. It is intended for hospital use only to nebulize physician-prescribed medications for inhalation which are approved for use with a general purpose nebulizer. The Aerogen® Solo nebulizer is for single patient use only and the Aerogen® Pro-X Controller is for re-use.

The Aerogen Solo System is suitable for intermittent and continuous nebulization of pediatric (29 days or older) and adult patients as described in this manual.

Indications for Use

The Aerogen Solo Nebulizer System is a portable medical device for single patient use that is intended to aerosolize physician-prescribed solutions for inhalation to patients on and off ventilation or other positive pressure breathing assistance.

Aerogen Solo System

The Aerogen Solo System includes the following components:

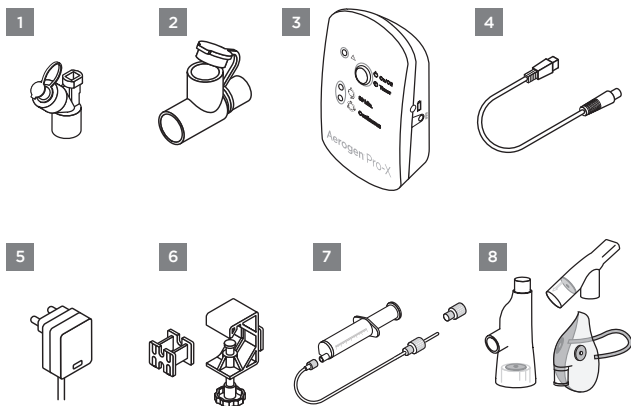

Figure 1. Aerogen Solo System

1. Aerogen Solo With Plug
2. T-Piece (Adult)*
3. Aerogen Pro-X Controller
4. Controller Cable
5. AC/DC Adapter
6. Universal Mounting Bracket & Equipment Mount Adapter
7. Continuous Nebulization Tube Set*
8. Aerogen® Ultra* with Mouthpiece and I-Guard™ Aerosol Mask

* Pediatric adapters, Continuous Nebulization Tube Set and the Aerogen Ultra are sold separately. Visit www.aerogen.com for full parts list.

System Warnings

Read and study all instructions before using the Aerogen Solo System and accessories. Only trained medical personnel should operate the device.

This is a single patient use device not to be used on more than one patient to prevent cross infection.

The components and accessories of the Aerogen Solo System, as packaged, are not sterile.

The components and accessories of the Aerogen Solo System are not made with natural rubber latex.

Inspect all parts before use, and do not use if any parts are missing, cracked or damaged. In case of missing parts, malfunction or damage, contact your sales representative.

Only use physician-prescribed solutions that are approved for use with a general purpose nebulizer. Consult drug manufacturer's instructions regarding suitability for nebulization.

Use only with Aerogen Solo components, connectors and any accessories, which are specified by Aerogen in this instruction manual.

Do not use beyond defined life (see page 18 for the Aerogen Ultra and page 31 for the Aerogen Solo System).

Do not use in the presence of flammable substances or flammable anesthetic mixtures combined with air, oxygen or nitrous oxide.

To avoid the risk of fire, do not use to aerosolize alcohol-based medications, which can ignite in oxygen-enriched air and under high pressure.

Do not autoclave any component or accessory of the Aerogen Solo System.

Do not modify this equipment without the authorization of the manufacturer.

To avoid damage to the nebulizer:

- Do not apply undue pressure to the domed aperture plate in the center of the nebulizer.
- Do not push out the Aerogen Vibronic® aerosol generator.
- Do not use a syringe with a needle to add medication.
- Do not attempt to clean the nebulizer.

Do not use or store outside of specified environmental conditions.

Federal (US) Law restricts this device to sale by or on the order of a physician.

Use of the Aerogen Solo and T-piece during the administration of volatile anesthetics may result in adverse effects on the constituent plastics. Do not use with volatile anesthetics unless known to be compatible. Aerogen have determined that, using anesthetic ventilators, the following volatile anesthetic agents are compatible under the stated conditions below:

Anesthetic Agent	Proprietary Name	Maximum Percentage of Anesthetic	Maximum Duration of Exposure
Isoflurane	FORANE®	3.5 %	12 hours
Sevoflurane	SEVOFLURANE®	8 %	12 hours
Desflurane	SUPRANE®	10 %	12 hours

Assembly & Installation

Aerogen Solo System Set-Up

Perform a functional test of the Aerogen Solo before use as described in the Functional Test section of this manual (See page 27).

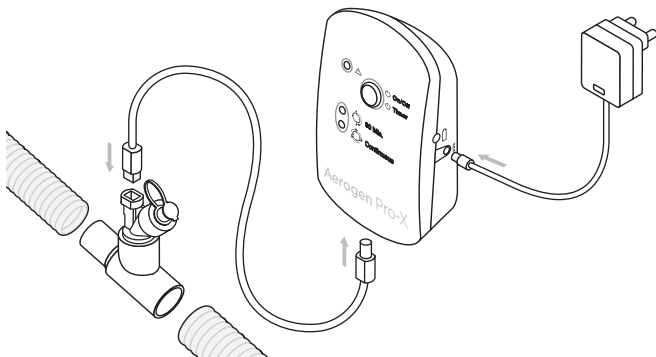

Figure 2. Assembly of Aerogen Solo System

1. Connect the Aerogen Solo to the T-piece by pushing the nebulizer firmly onto the T-piece.
2. Insert the Aerogen Solo and the T-piece into the breathing circuit.
Note: For use with other accessories, refer to Figure 12, Figure 13 and Figure 14.
3. Connect the Aerogen Pro-X Controller to the Aerogen Solo using the nebulizer cable.
4. To operate on AC power (the primary mode of operation), connect the Aerogen Pro-X AC/DC adapter to the Aerogen Pro-X Controller.
5. Plug the adapter into an AC power source.

6. The Aerogen Pro-X Controller can be battery-operated for portable applications. The rechargeable battery can power the System for up to 45 minutes when fully charged. In the case of AC power failure the controller will automatically switch to battery operation.
7. Use the universal mounting bracket to attach the controller to an IV pole or bed rail in either a vertical or horizontal orientation (Figure 3).
8. Where a standard equipment mount is available, use the equipment mount adapter to support the controller (Figure 3).

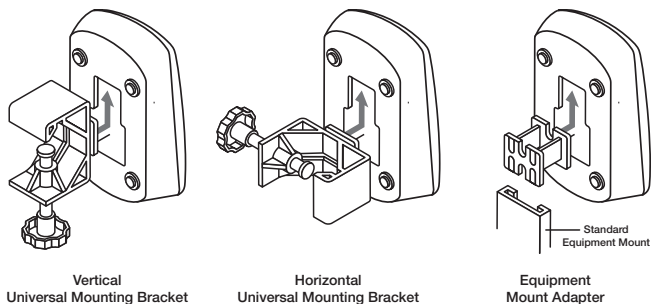

Figure 3. Aerogen Pro-X Controller and universal mounting bracket configurations

Warnings

- To ensure uninterrupted operation of the Aerogen Solo, secure both the AC/DC adapter cable and the controller cable so they cannot become disconnected during treatment. If clips are available on patient circuits, run the cables through the eyes of the clips. If clips are not available, ensure that all cables are routed safely.
- The AC/DC adapter is the means of isolating the Aerogen Solo System from the mains power supply.
- The continuous mode can only be operated from AC power supply.
- Do not over-tighten knob on the universal mounting bracket.

Aerogen Pro-X Controller

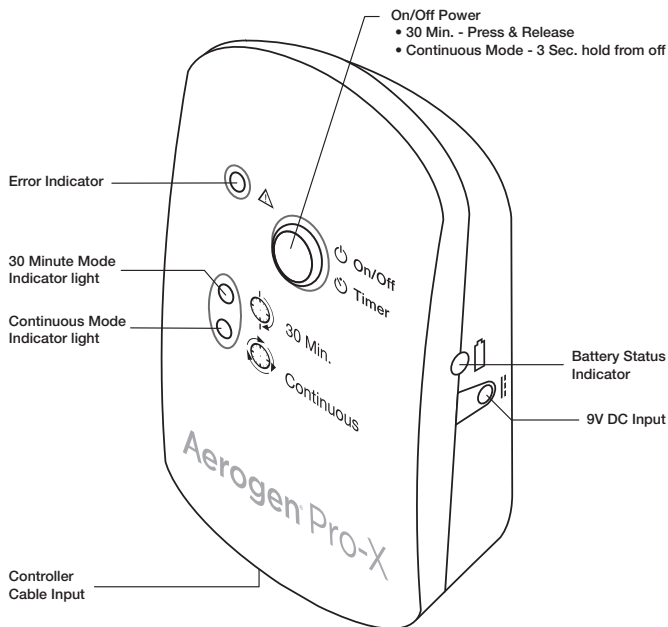

Figure 4. Aerogen Pro-X Controls & Indicators

Table 1. Aerogen Pro-X Controls & Indicators

Control / Indicator	Function
30 Min. Indicator	<ul style="list-style-type: none">Green (steadily lit) = 30 Minute nebulization cycle onGreen (flashing) = Low battery powerNebulizer automatically powers off after 30 minutes have elapsed
Continuous Indicator	<ul style="list-style-type: none">Green (steadily lit) = Continuous nebulization cycle onNebulizer does not power off automatically
Error Indicator	<ul style="list-style-type: none">Amber (steadily lit) = Aerogen Solo nebulizer disconnected from Aerogen Pro-X ControllerAmber (flashing) = Aerogen Pro-X drive voltage error
On/Off Power Button	<ul style="list-style-type: none">To operate in 30 Minute Mode, press the On/Off button onceTo operate in Continuous Mode, press and hold the On/Off button for greater than 3 seconds from offPressing during nebulization turns off power to the nebulizer
Battery Status Indicator	<ul style="list-style-type: none">Green = Battery fully chargedAmber = Battery chargingNo light = Battery in operation

Recharging the Battery

To recharge the battery, connect the AC/DC adapter to the controller and connect to AC power source. The battery status indicator is amber while charging and green when fully charged.

If the controller is placed in long-term storage, it is recommended that the battery be recharged every 3 months.

Allow a minimum of four hours for the internal battery to fully recharge.

Cleaning the Aerogen Pro-X Controller

Cleaning of controller and controller cable, AC/DC adapter and mounting brackets:

1. Wipe clean with an alcohol based disinfectant wipe or a quaternary ammonium compound based disinfectant wipe.
2. Check for exposed wiring, damaged connectors, or other defects and replace controller if any are visible.
3. Visually inspect for damage and replace the controller if any damage is observed.

Warnings

- Do not immerse or autoclave the Aerogen Pro-X Controller, cable or AC/DC adapter.
- Do not place the Aerogen Pro-X Controller in an incubator during use.
- Do not use abrasive or sharp tools.
- Do not spray liquid directly onto the controller.
- Do not wrap the nebulizer cable tightly around any of the system components.
- Do not use in the presence of devices generating high electromagnetic fields such as magnetic resonance imaging (MRI) equipment.
- The Aerogen Pro-X Controller contains a nickel metal hydride (NiMH) rechargeable battery, which should be disposed of in accordance with local governing regulations at the end of its useful life.
- Follow local laws and recycling plans regarding disposal or recycling of components, batteries and packaging.

Installation for use with a Ventilator

T-Pieces - Connection to a Breathing Circuit

1. For 22mm **adult breathing circuits** connect the nebulizer with adult T-piece into the inspiratory limb of the breathing circuit before the patient Y (Figure 5).

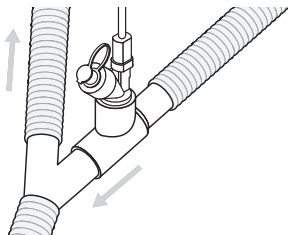

Figure 5. Connecting the Aerogen Solo to an adult breathing circuit

For 15mm **pediatric breathing circuits** connect the nebulizer with the pediatric T-piece into the inspiratory limb of the breathing circuit before the patient Y, as shown for the adult T-piece in Figure 5.

The Aerogen Solo can connect to 10mm pediatric breathing circuits with the 15mm pediatric T-piece and the pediatric adapters. This can be positioned approximately 30cm (12 in.) back from the patient Y (Figure 6).

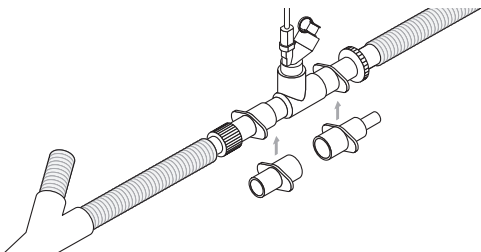

Figure 6. Connecting to a pediatric breathing circuit

2. The Aerogen Solo can be placed between the ventilator and the dry side of the humidifier. Figure 7 illustrates a set up for the Aerogen Solo at the dry side of the humidifier. The Aerogen Solo can be used with a nasal interface in this configuration.

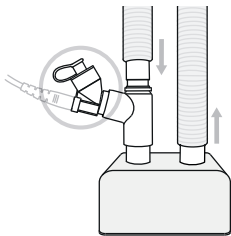

Figure 7. Aerogen Solo on dry side of humidifier

3. The Aerogen Solo can be placed between the wye and endotracheal tube as shown in Figure 8. The Aerogen Solo can be used with a Heat and Moisture Exchange Device (HME) which may contain a filter.

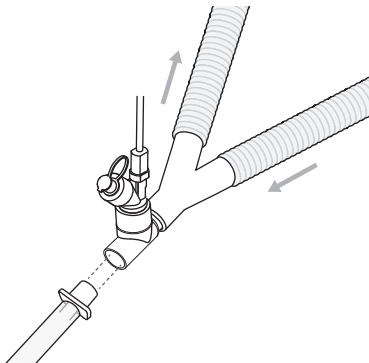

Figure 8. The Aerogen Solo placed between the wye and endotracheal tube.

- Only a HME approved for use with a nebulizer should be used in this configuration (Figure 9). Follow the HME manufacturer instructions regarding use with a nebulizer. Ensure the combination of nebulizer, T-piece and HME volumes is suitable for the tidal volume being delivered. See Table 3 for T-piece volumes.

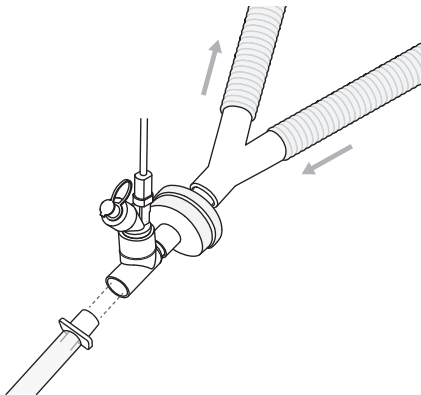

Figure 9. The Aerogen Solo placed between the HME and endotracheal tube.

- Follow ventilator manufacturer instructions for performing a leak test after inserting or removing the nebulizer.

Warnings

- Only use with HME devices whose manufacturer's instructions allow use with a nebulizer, and always follow the HME manufacturer's instructions.
- Ensure that the total combined volume of nebulizer, T-piece and/or HME is suitable for the tidal volume being delivered and does not increase dead space to the extent that it adversely impacts the ventilatory parameters of the patient.

- Always monitor the resistance to flow and excessive rain-out and change the HME device as per manufacturer's instructions.
- Do not use a filter or heat-moisture exchanger (HME) between the nebulizer and patient airway.
- Condensate can collect and occlude ventilator circuits. Always position ventilator circuits so that fluid condensate drains away from the patient.
- Always connect a bacteria filter to the expiratory inlet of the ventilator. Otherwise the function of the expiratory channel may be degraded.

Installation for use with Non-Invasive Ventilation

The Aerogen Solo is suitable for use with non-invasive ventilation in a dual limb circuit as shown above in Figures 5, 7, 8 & 9.

The Aerogen Solo can be used with single limb NIV circuits using non vented masks where the nebuliser can be placed between the exhalation port and the patient as shown in Figure 10.

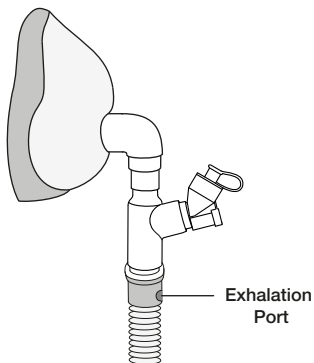

Figure 10. Connecting the Aerogen Solo to a non-invasive single limb circuit

Optimum Use

For optimum use of the Aerogen Solo, ensure it is correctly orientated as shown in Figure 11. This applies to both 30 Minute and Continuous modes.

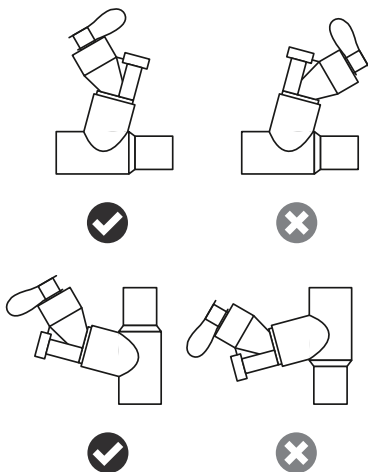

Figure 11. Optimum Use of the Aerogen Solo

Installation for use Off-Ventilator

Use with a Face Mask

Mask kits, which include a vented elbow and mask elbow, are available separately (visit www.aerogen.com for full parts list).

1. When using a mask, connect the vented elbow, mask elbow and mask to the nebulizer by firmly pushing the parts together.
2. Rotate the vented elbow to suit the position of the patient (Figure 12).

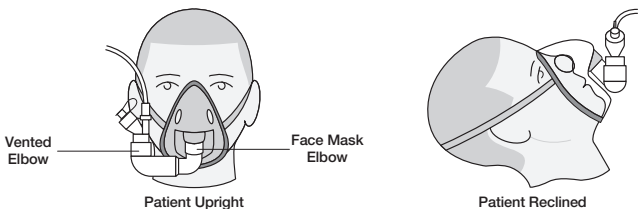

Figure 12. Connecting to a mask

Use with a Mouthpiece

The Aerogen Solo is compatible with any standard ISO 22mm nebulizer mouthpiece inserted into the adult T-piece.

When using a mouthpiece, connect the nebulizer to the T-piece and then connect the T-piece to the mouthpiece by pushing the parts firmly together as shown in Figure 13.

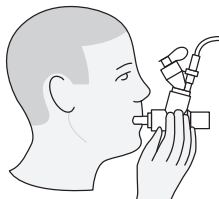

Figure 13. Connecting to a mouthpiece

Warning: To ensure correct nebulization, maintain the nebulizer in a vertical orientation (Figure 12 & Figure 13).

Use with a Nasal Interface

The Aerogen Solo can be used on/off ventilator with a nasal interface when configured with a humidifier (Figure 7).

Aerogen Ultra

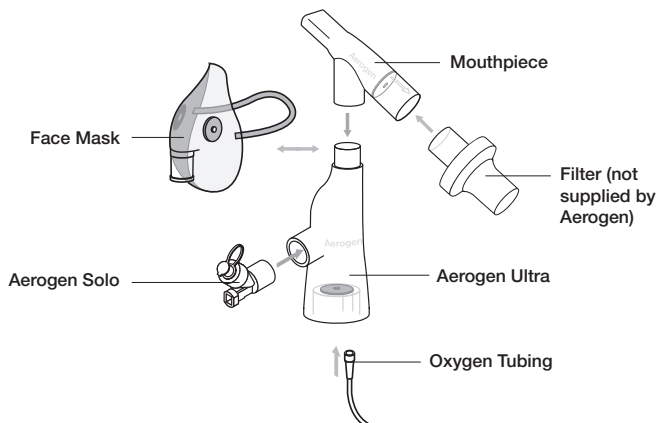

Figure 14. Assembly of Aerogen Ultra

- The Aerogen Ultra is an accessory specific to the Aerogen Solo nebulizer.
- It facilitates intermittent and continuous nebulization and optional supply of supplemental oxygen to pediatric (29 days or older) and adult patients in hospital use environments via mouthpiece or aerosol face mask. If supplemental oxygen is used, for pediatric patients under 18 years of age, a maximum flow rate of 2 LPM should be used.

Note: The mouthpiece should not be used for children under 5 years of age.

- The Aerogen Ultra is for spontaneous and conscious breathing patients only.
- The Aerogen Ultra, Mouthpiece, Aerogen Solo nebuliser, oxygen tubing and I-Guard™ Aerosol Mask are non-sterile.
- The filter is not supplied by Aerogen. The image of the filter has been included for demonstration purposes. It is the responsibility of the clinician to determine if a filter is required and the type of filter selected for use (Viral/Bacterial) in conjunction with the Aerogen Ultra.
- If using the Aerogen Ultra in conjunction with a filter, refer to the filter manufacturer's Instructions for Use for information including filter disposal.
- For disposal of the Aerogen Ultra, Mouthpiece, Aerogen Solo nebuliser and oxygen tubing, refer to hospital or institutional protocol, for disposal of the I-Guard™ Aerosol Mask refer to manufacturer's instructions.

The Aerogen Ultra is a single patient use device with a validated defined life of:

- In intermittent use for a maximum of 20 treatments; which is based upon a typical usage profile of four 3 mL doses per day over 5 days, with an average treatment time of 9 minutes.
or
- In continuous use, for a maximum of 3 hours.
- The Aerogen Ultra can be used in conjunction with the Aerogen Solo Continuous Nebulization Tube Set (see page 24).
- Optimal aerosol delivery is achieved with valved mouthpiece or valved face mask (as supplied) with low/no oxygen flow.

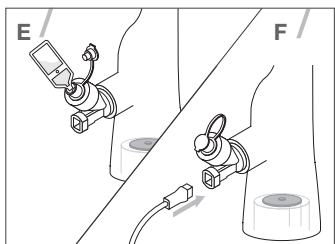
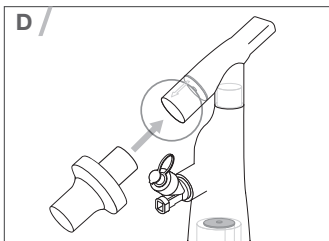
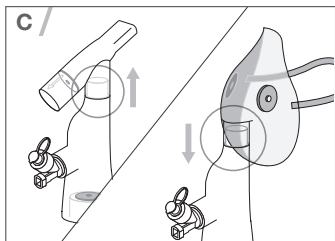
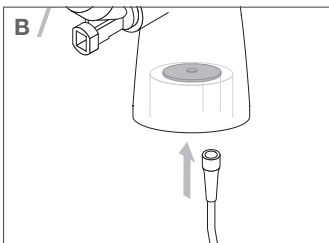
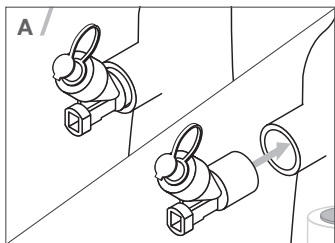

F /

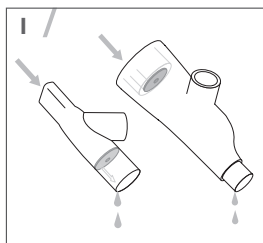
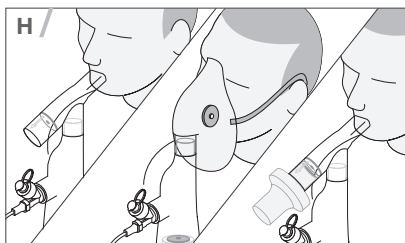
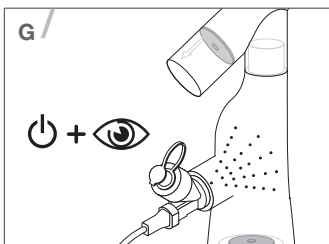

Refer to Figures A - I on page 20

Inspect for device integrity and correct valve placement prior to use.

A. Insert the Aerogen Solo nebulizer firmly into the Aerogen Ultra in orientation shown in Figure 14.

B. If supplemental oxygen is required, firmly attach oxygen tubing to the Aerogen Ultra.

Note: Oxygen flow rate should be set between 1-6 LPM for adult and a maximum of 2 LPM for pediatric patients less than 18 years of age.

C. If an aerosol face mask is required, remove mouthpiece and attach the aerosol face mask to the Aerogen Ultra.

Note: When using an aerosol face mask, a minimum oxygen flow of 1 LPM is required.

D. If use of a filter is required, the Aerogen Ultra Mouthpiece has a 22mm(F) ISO 5356-1 connection port to facilitate the attachment of a ISO 5356-1 compliant filter port.

E. Add medication to nebulizer.

F. Connect cable to the Aerogen Solo.

G. Power on and observe Aerogen Ultra to confirm aerosol is visible.

H. Introduce the Aerogen Ultra to patient and observe aerosol flow to ensure correct operation.

I. Remove excess rainout from the Aerogen Ultra periodically (hourly with continuous nebulization). To ensure optimum performance of the Aerogen Ultra, remove any residue by rinsing through with sterile water, shake off excess and allow to air dry.

Warnings

- Do not use with a closed face mask or a standard oxygen mask.
- When using with an aerosol face mask, always use supplemental oxygen flow of 1-6 LPM for adult and a maximum of 2 LPM for pediatric patients less than 18 years of age.

- Performance of the Aerogen Ultra may vary depending upon the type of drug and Aerogen Ultra configuration used.
- Do not exceed recommended oxygen flow for system.
- Ensure oxygen connection port or tubing is not occluded.
- Do not use the Aerogen Ultra without a mouthpiece or face mask.
- Visually check the Aerogen Ultra post-rinsing to ensure that valves have not become dislodged.
- Do not cover the Aerogen Ultra valves during use.
- Do not use the Aerogen Ultra in conjunction with the Aerogen Pro nebulizer.
- Do not autoclave any component of the kit.
- Ensure tubing is safely orientated to prevent strangulation hazard.
- Change the filter as per manufacturer instructions or more frequently if it becomes obstructed.
- When connecting a 22mm(M) breathing system filter to the Aerogen Ultra mouthpiece, ensure that the filter does not occlude the exhalation valve of the mouthpiece.

Nebulization Modes

30 Minute Mode (Intermittent)

Warnings

- To avoid damage to the Aerogen Solo, do not use a syringe with a needle.
- During use observe for correct functioning of the nebulizer.
- The maximum capacity of the nebulizer is 6 mL.

For intermittent doses less than or equal to 6 mL:

1. Open the plug on the nebulizer.
2. Use a pre-filled ampoule or syringe to add medication into the filler port of the nebulizer (Figure 15).
3. Close the plug.

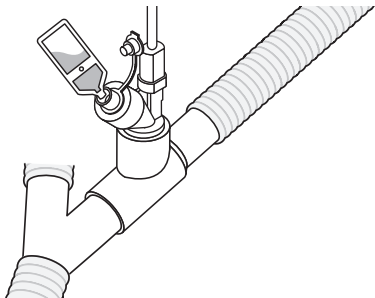

Figure 15. Filling the nebulizer with a pre-filled ampoule

4. To start a 30 Minute nebulization cycle, press and release the blue On/Off power button (Figure 4). The green 30 Minute indicator light illuminates to indicate that the 30 Minute nebulization cycle is in progress.
5. To stop the nebulizer at any time, press the On/Off power button. The indicator turns off to indicate that nebulization has stopped.

Note: Medication can be added to the Aerogen Solo during nebulization. This does not interrupt nebulization or ventilation.

Continuous Mode

Continuous Nebulization Tube Set

The Aerogen Continuous Nebulization Tube Set is an accessory specific to the Aerogen Solo nebulizer which enables safe continuous infusion of liquid medication for aerosolization.

Note: Place the syringe cap on the syringe after it is filled with medication.

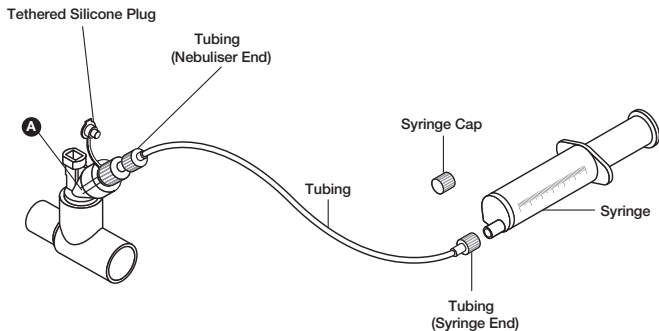

Figure 16. Continuous Nebulization Tube Set

1. Ensure the Aerogen Solo nebulizer is firmly fitted into the Aerogen Solo T-piece in the breathing circuit.
2. Remove the syringe cap from the medication-filled syringe.
3. Attach the syringe end of the tubing onto the syringe.
4. Prime the tubing until the medication reaches end of tubing (Point A).

Note: The tubing priming volume is maximum 3.65 mL.

5. Unplug the tethered silicone plug from the Aerogen Solo nebulizer, but do not remove it from the nebulizer.
6. Screw the nebulizer end of the tubing onto the top of the nebulizer.
7. Insert the syringe filled with medication into the syringe infusion pump (pump not shown in Figure 16) and set the appropriate flow rate (refer to pump manual or manufacturer for guidance).
8. To start a continuous nebulization cycle, press and hold the blue On/Off power button from the off state for at least three seconds. Verify the green, 'continuous nebulization' indicator light is on (Figure 4).
9. Observe nebulizer for correct operation. During continuous nebulization, the nebulizer is on continuously and the medication is nebulized on a drop by drop basis. Nebulization should be visible with regular intermittent pauses. Medication level in the nebulizer reservoir should not rise during use.
10. To stop the nebulizer at any time, press the On/Off power button. The indicator turns off to indicate that nebulization has stopped.

Aerogen's recommended input rate of medication into the Aerogen Solo nebulizer during continuous nebulization is up to a maximum of 12 mL per hour. The upper limit of 12 mL per hour is based on Aerogen's specification for the minimum nebulizer flow rate. For directions on determining flow rates, refer to the Optional Flow Rate Calculation method in the Functional Test section, page 28.

Warnings Specific to the Continuous Nebulization Tube Set

- It is important to ensure that the maximum flow rate through the tube set into the nebulizer must not exceed the output rate of the nebulizer.
- Check for leaks from the system prior to and during use.
- The graduations on the syringe are for indication use only.
- Store at room temperature and use product within labeled shelf life.
- To ensure correct and safe connection between the nebulizer and the medication reservoir, trace the medication tube from the nebulizer back to the medication reservoir to make sure the medication tube is connected to the correct source.

- The recommended syringe pump software setting with the Aerogen syringe is typically the “BD Plastipak” setting. This must be validated locally before use. Refer to pump manual or manufacturer for guidance. These pumps may also be used in accordance with local hospital or ward policies.
- Ensure that the tethered silicone plug is attached to the Aerogen Solo when connecting tube set.
- Ensure that the tubing is safely orientated to prevent a trip hazard.
- Rising level of medication in the reservoir may occur if the Aerogen Solo nebulizer is turned off while the feed system is still on or the nebulizer is not in its recommended orientation.
- The level of the medication in the reservoir of the Aerogen Solo nebulizer should be periodically monitored to ensure that the fill rate of medication does not exceed the output rate of the nebulizer. A rising level of medication in the reservoir indicates that the fill rate is exceeding the output rate of the nebulizer.
- Replace both the tube set and syringe when changing the type of medication.
- If the syringe needs to be replaced during use (even when empty), turn off the syringe pump and disconnect the nebulizer end of the tube set first. Failure to do this may result in primed medication in the tube flowing into the nebulizer reservoir.
- To avoid spillage of medication when changing the syringe tubing, keep both ends of the tubing at the same height.
- Do not connect the tube set and syringe to non-respiratory equipment.
- Do not clean or sterilize.
- Do not connect to any nebulizer other than the Aerogen Solo.

Note: If the mains power is disconnected during a continuous nebulization cycle and reconnected within 10 seconds, the controller shall return to Continuous Nebulization mode automatically.

Functional Test

Perform a functional test of the Aerogen Solo System prior to first use or at any time to verify proper operation. This test is to be carried out prior to inserting the nebulizer into a circuit or accessory.

1. Visually inspect each part of the system for cracks or damage and replace if any defects are visible.
2. Pour 1-6 mL of normal saline (0.9%) into the nebulizer.
3. Connect the nebulizer to the controller using the controller cable. Connect the AC/DC adapter to the controller and plug the AC/DC adapter into an AC power source.
4. Press and release the blue On/Off power button and verify that the green 30 Min. indicator light illuminates and that aerosol is visible.
5. Disconnect the nebulizer from the controller. Verify that the amber Error Indicator lights. Reconnect the nebulizer to the controller.
6. Disconnect the AC/DC adapter from the controller and verify that nebulization continues and that the battery status indicator turns off.
7. Power off the controller. Reconnect the AC/DC adapter to the controller. Press and hold the button for at least 3 seconds. Verify that the green Continuous indicator light illuminates and that aerosol is visible.
8. Turn the system off and verify that the 30 Min. and Continuous indicators are off.

Aerogen Solo Aerosol Flow Rate Calculation (Optional)

Flow rates may vary between individual Aerogen Solo nebulizers. The minimum flow rate for all Aerogen Solo nebulizers is 0.2 mL per minute. In order to calculate the flow rate of an individual Aerogen Solo nebulizer, follow these steps:

1. Transfer 0.5 mL of normal saline (0.9%) or intended drug into the Aerogen Solo medication cup.
2. Turn on the nebulizer.
3. Using a stop-watch, measure the length of time it takes from the start of nebulization until all the saline/drug has been nebulized.

$$\text{Flow rate in mL/min} = \left(\frac{\text{Volume of normal saline or drug}}{\text{Nebulization time in seconds}} \right) \times 60$$

$$\text{Flow rate in mL/hr} = \left(\left(\frac{\text{Volume of normal saline or drug}}{\text{Nebulization time in seconds}} \right) \times 60 \right) \times 60$$

Troubleshooting

If these suggestions do not correct the problem, discontinue use of any device and contact your local Aerogen sales representative.

Table 2. Aerogen Pro-X Controller Troubleshooting

If this happens:	It could mean:	Try this:
The 30 Min. indicator flashes during nebulization.	Battery power is low.	Recharge battery (see Recharging the Battery).
Battery will not recharge. Controller is connected to the AC/DC adapter and the battery charging light is illuminated green and the 30 Min. indicator light is flashing.	It may be time to replace the battery.	Contact your local Aerogen sales representative.
Battery will not retain initial charge.	Rechargeable battery may need to be replaced.	Contact your local Aerogen sales representative.
The 30 Min. or Continuous light illuminates, but aerosol is not visible.	No medication in nebulizer.	Refill medication through filler cap in the nebulizer (see page 23).
	It may be time to replace the nebulizer.	See Warranty and Life of Product. Refer to Aerogen Solo parts list by visiting www.aerogen.com .
30 Min. or Continuous indicator does not light when On/Off power button is pressed.	There is no power to the system.	Verify that AC/DC adapter is securely attached to controller.
	Rechargeable battery is depleted.	Recharge battery (see Recharging the Battery).
The error indicator light illuminates.	The controller cable is incorrectly connected to the nebulizer, or electronics are malfunctioning.	Verify that controller cable is correctly connected to both the nebulizer and the controller.

Table 2. Aerogen Pro-X Controller Troubleshooting (Continued) /

If this happens:	It could mean:	Try this:
Medication is left in the nebulizer after nebulization cycle.	Nebulizer was not turned on or connected to power.	Ensure that nebulizer is connected to power and turned on.
	Rechargeable battery is depleted.	Recharge battery (see Recharging the Battery).
	A 30 Minute cycle was selected when connected to the continuous feed system.	Run a continuous cycle.
	It may be time to replace the nebulizer.	See Warranty and Life of Product. Refer to Aerogen Solo parts list by visiting www.aerogen.com .
Flashing amber light.	It may mean that it is time to replace controller.	Contact your local Aerogen sales representative.

Note: The rechargeable battery in the Aerogen Pro-X Controller should only be replaced by Aerogen authorized personnel: contact your Aerogen sales representative.

Warranty

Aerogen warrants that the Aerogen Solo nebulizer shall be free from defects of workmanship and materials for a period of the defined life of the nebulizer when used in accordance with this instruction manual.

The Aerogen Pro-X Controller and AC/DC adapter are warranted against defects in manufacturing for a period of two years from the date of purchase. All warranties are based on typical usage, detailed below.

Life of Product

As with all active electronic components, the Aerogen Solo nebulizer has a defined life. In the case of Aerogen Solo, the life of the nebulizer has been validated for intermittent use for a maximum of 28 days based upon a typical usage profile of 4 treatments per day.

For continuous use, the life of the Aerogen Solo nebulizer and the continuous nebulization tube set have been qualified for use for a maximum of 7 days.

The user should note that use in excess of these periods is not qualified by Aerogen.

Specifications

Table 3. Physical Specifications of the Aerogen Solo System /

Nebulizer Dimensions		67 mm H x 48 mm W x 25 mm D 2.6" H x 1.88" W x 1.1" D
Aerogen Pro-X Controller Dimensions		33mm H x 75mm W x 131mm D 1.3" H x 2.9" W x 5.2"D
Controller Cable Length		1.8 m (5.9 ft.)
AC/DC Adapter Cable Length		2.1 m (6.7 ft.)
Nebulizer Weight		13.5 g (0.5 oz) nebulizer and plug
Aerogen Pro-X Controller Weight		230 g (8.1 oz.), including battery and cable
Nebulizer Capacity		Maximum 6 mL
T-piece Volume	Adult	34.3 mL
	Pediatric (15 mm)	19.5 mL

Table 4. Environmental Specifications of the Aerogen Solo System /

Operating	Maintains specified performance at circuit pressures up to 90cm H ₂ O and temperatures from 5 °C (41°F) up to 45 °C (113°F).	
	Atmospheric Pressure	450 to 1100 mbars
	Humidity	15% to 95% relative humidity
	Noise Level	< 35 dB measured at 0.3 m distance
Storage & Transport	Transient Temperature Range	-20 to +60°C (-4 to +140°F)
	Atmospheric Pressure	450 to 1100 mbars
	Humidity	15 to 95% relative humidity

Table 5. Power Specifications of the Aerogen Solo System /

Power Source	FRIWO (AG-AP1040-US) AC/DC adapter (input 100 to 240 VAC 50 – 60 Hz, output 9 V) or internal rechargeable battery (4.8 V nominal output). Note: The Aerogen Pro-X Controller is approved for use with Aerogen AC/DC adapter AG-AP1040-US (Manufacturer Reference: FRIWO FW8000M/US/09 / FW8000M/09 / FW7660M/09)
Power Consumption	≤ 8.0 Watts (charging), ≤ 2.0 Watts (nebulizing).
Patient Isolation	Controller circuitry provides 4 kilovolt (kV) patient isolation and complies with IEC/EN 60601-1.

Performance

Table 6. Performance Specifications of the Aerogen Solo /

Flow Rate	> 0.2 mL/min (Average ~ 0.38 mL/min)
Particle Size	<p>As measured with the Andersen Cascade Impactor: Specification Range: 1-5 µm Average Tested: 3.1 µm</p> <p>As per EN 13544-1: Aerosol Output rate: 0.30 mL/min Aerosol Output: 1.02 mL emitted of 2.0 mL dose Residual Volume: <0.1 mL for 3 mL dose</p>
Performance may vary depending upon the type of drug and nebulizer used. For additional information contact Aerogen or drug supplier.	
The temperature of the medication will not rise more than 10°C (18°F) above ambient during normal use.	

Table 7 shows the results of aerosol performance testing for the Aerogen Solo using an 8 stage cascade impactor running at a continuous flow rate of 28.3 LPM. Indicated ranges correspond to confidence intervals with a confidence level of 95%.

Table 7. Aerogen Solo Aerosol Performance Testing /

	Albuterol Sulphate (1mg/ml)	Ipratropium (0.25mg/ml)	Budesonide (0.5mg/ml)
Particle size (µm)	2.90 - 3.23	3.07 - 3.42	3.45 - 3.79
Geometric Standard Deviation (GSD)	2.09 - 2.35	1.80 - 1.93	1.92 - 2.14
Emitted Dose (% of fill)	97.23 - 99.30	97.61 - 98.64	94.12 - 97.84
Respirable Dose (0.5 – 5.0 µm) (% of fill)	67.66 - 73.50	71.78 - 76.69	62.32 - 66.90
Coarse particle Dose (>4.7 µm) (% of fill)	27.00 - 31.11	23.62 - 28.21	32.31 - 36.12

Table 7. Aerogen Solo Aerosol Performance Testing (Continued)

	Albuterol Sulphate (1mg/ml)	Ipratropium (0.25mg/ml)	Budesonide (0.5mg/ml)
Fine particle Dose ($<4.7 \mu\text{m}$) (% of fill)	66.33 - 72.07	68.58 - 73.84	59.36 - 64.17
Ultra-fine Particle Dose ($<1.0 \mu\text{m}$) (% of fill)	5.91 - 9.93	1.85 - 4.19	2.36 - 4.51

Table 8 shows the Inhaled Dose (%) for the Aerogen Solo Nebulizer and Aerogen Ultra with supplemental gas flow, measured on a breathing simulator.

Table 8. Inhaled Dose (%) for the Aerogen Solo and Aerogen Ultra

Gas Flow Rate (LPM)	Breathing Profile	Patient Interface		
		Mouthpiece	Open Face Mask	Valved Face Mask
0	Adult	73.5 – 61.6	N/A	70.7 – 52.3
	Pediatric	54.5 – 45.6	N/A	52.9 – 42.5
2	Adult	73.8 – 59.2	44.0 – 37.7	65.4 – 45.3
	Pediatric	55.2 – 40.9	34.4 – 29.2	42.4 – 34.7
6	Adult	52.1 – 47.3	41.6 – 34.7	48.4 – 39.5
Results are Inhaled Dose %, expressed as a % of the Nominal Dose placed in the Aerogen Solo nebulizer, across a range of supplemental gas flows. The results provided are the maximum and minimum values for 3 devices tested at each flow rate with each interface.				
Adult Profile: 500ml Vt, 15BPM, 1:1 I:E; Pediatric Profile: 155ml Vt, 25 BPM, 1:2 I:E.				

Symbols Glossary

Table 9. Aerogen Solo System Symbols

















Symbol	Meaning	Symbol	Meaning
YYXXXXX	Serial number designation, where YY is the year of manufacture and XXXXX is the serial number		Transient storage temperature limitations -20 °C to +60 °C
	Caution Attention: Consult accompanying documents	QTY	Quantity (Number of units contained in package)
 IPX1	Degree of protection against dripping water	Rx Only	Federal (US) Law restricts this device to sale by or on the order of a physician.
	Class II equipment per IEC/EN 60601-1		Certified by TUV with respect to electric shock, fire and mechanical hazards
	Type BF equipment per IEC/EN 60601-1		Controller Input - DC voltage
	On/Off power button		Controller Output – AC voltage
	30 Minute operating mode		Output
	Continuous operating mode		Battery status indicator
	Refer to instruction manual/booklet		Not made with natural rubber latex

Table 9. Aerogen Solo System Symbols (Continued) /

Symbol	Meaning	Symbol	Meaning
	<p>Consult instructions for use: Indicates the need for the user to consult the instructions for use.</p>		<p>This product is supplied non-sterile</p>

Appendix 1

Electromagnetic Susceptibility

This device meets the requirements of the Electromagnetic Compatibility (EMC), pursuant to the Collateral Standard, IEC/EN 60601-1-2, which addresses EMC in North America, Europe and other global communities. This includes immunity to radio frequency electric fields and electrostatic discharge, in addition to the other applicable requirements of the standard. Compliance with EMC standards does not mean a device has total immunity; certain devices (cellular phones, pagers, etc.) can interrupt operation if they are used near medical equipment. Follow institutional protocol regarding the use and location of devices that could interfere with medical equipment operation.

Note: This device is classified as Class II Type BF medical electrical equipment and the device complies with specified safety levels for electrical isolation and leakage current. The Aerogen Solo AC/DC adapter (AG-AP1040-US) has no connection to earth ground because the necessary level of protection is achieved through the use of double insulation.

Warnings

- Only use the Aerogen Solo nebulizer with components specified in the Instruction Manual. Use of the Aerogen Solo nebulizer with components other than those specified in the Instruction Manual may result in increased emissions or decreased immunity of the Aerogen Solo nebulizer system.
- Do not use the Aerogen Solo adjacent to or stacked with other equipment. If adjacent or stacked use is necessary, the device should be observed to verify normal operation in this configuration.
- The Aerogen Solo needs special precautions regarding electromagnetic compatibility (“EMC”) and must be installed and put into service according to the EMC information provided in the Instruction Manual.
- Portable and mobile radio frequency (“RF”) communication devices can disrupt medical electrical equipment.

This page has been intentionally left blank

Appendix 1: EMC Tables

The following tables are provided in accordance with IEC/EN 60601-1-2:

Table 10. Guidance and manufacturer's declaration – electromagnetic emissions

The Aerogen Solo nebulizer system is intended for use in the electromagnetic environment specified below. The customer or the user of the Aerogen Solo nebulizer system should assure that it is used in such an environment.		
Emissions test	Compliance	Electromagnetic Environment - Guidance
RF Emissions Conducted and Radiated CISPR 11 EN 55011: 2009 + A1: 2010	Group 1	The Aerogen Solo nebulizer system uses RF energy only for its internal function. Therefore, its RF emissions are very low and are not likely to cause any interference in nearby electronic equipment.
RF Emissions Conducted and Radiated CISPR 11 EN 55011: 2009 + A1: 2010	Class B	The Aerogen Solo nebulizer system is suitable for use in all establishments, including domestic establishments and those directly connected to the public low-voltage power supply network that supplies buildings used for domestic purposes.
Harmonic emissions IEC 61000-3-2 EN 61000-3-2: 2014	Compliant	
Voltage fluctuations / flicker emissions IEC 61000-3-3 EN 61000-3-3: 2013	Compliant	

Table 11. Recommended separation distances between portable and mobile RF communication equipment and the Aerogen Solo nebulizer system that is not life supporting

This Aerogen Solo nebulizer system is intended for use in an electromagnetic environment specified in Table 10. The customer or the user of the Aerogen Solo nebulizer system can help prevent electromagnetic interference by maintaining a minimum distance between portable and mobile RF communications equipment (transmitters) and the Aerogen Solo nebulizer system as recommended below, according to the maximum output power of the communications equipment.

Rated maximum output power of transmitter W	Separation distance according to frequency of transmitter m		
	150 kHz to 80 MHz $d = [1.17] \sqrt{P}$	80 MHz to 800 MHz $d = [1.17] \sqrt{P}$	800 MHz to 2.5 GHz $d = [2.33] \sqrt{P}$
0.01	0.12	0.12	0.23
0.1	0.37	0.37	0.75
1	1.17	1.17	2.33
10	3.70	3.70	7.36
100	11.70	11.70	23.30

For transmitters rated at a maximum output power not listed above, the recommended separation distance d in meters (m) can be estimated using the equation applicable to the frequency of the transmitter, where P is the maximum output power rating of the transmitter in watts (w) according to the transmitter manufacturer.

Note 1: At 80 MHz and 800 MHz, the separation distance for the higher frequency range applies.

Note 2: These guidelines may not apply in all situations. Electromagnetic propagation is affected by absorption and reflection from structures, objects and people.

Table 12. Guidance and manufacturer's declaration – electromagnetic immunity for the Aerogen Solo nebulizer system that is not life supporting

This Aerogen Solo nebulizer system is intended for use in the electromagnetic environment specified below. The customer or the user of the Aerogen Solo nebulizer system should assure that it is used in such an environment.

Immunity Test	IEC 60601 Test Level	Compliance Level	Electromagnetic Environment - Guidance
Electrostatic discharge (ESD)	±8 kV contact	±2, 4, 6 & 8 kV contact	Floors should be wood, concrete or ceramic tile. If floors are covered with synthetic material, the relative humidity should be at least 30%.
IEC 61000-4-2 EN 61000-4-2: 2009	±15 kV air	±2, 4, 6, 8 & 15 kV air	
Electrical fast Transient/burst	±2 kV for power supply lines	±2 kV for power supply lines	Mains power quality should be that of a typical commercial or hospital environment.
IEC 61000-4-4 EN 61000-4-4: 2012	±1 kV for input/output lines	±1 kV for input/output lines	
Surge	±1 kV line(s) to line(s)	±1 kV line(s) to line(s)	Mains power quality should be that of a typical commercial or hospital environment.
IEC 61000-4-5 EN 61000-4-5: 2006	±2 kV line(s) to earth	±2 kV line(s) to earth	
Voltage dips, short interruptions and voltage variations on power supply input lines	<5 % Ut (>95 % dip in Ut) for 0.5 cycle @ 0°, 45°, 90°, 135°, 180°, 225°, 270°, 315°	<5 % Ut (>95 % dip in Ut) for 0.5 cycle @ 0°, 45°, 90°, 135°, 180°, 225°, 270°, 315°	Mains power quality should be that of a typical commercial or hospital environment. If the user of the Aerogen Solo nebulizer system requires continued operation during power mains operation, it is recommended that the Aerogen Solo nebulizer system be powered from an uninterruptible power supply or battery.
IEC 61000-4-11 EN 61000-4-11: 2004	70 % Ut (30 % dip in Ut) for 25 cycles	70 % Ut (30 % dip in Ut) for 25 cycles	
	<5 % Ut (>95 % dip in Ut) for 5 sec	<5 % Ut (>95 % dip in Ut) for 5 sec	

Table 12. Guidance and manufacturer's declaration – electromagnetic immunity for the Aerogen Solo nebulizer system that is not life supporting (Continued)

Power frequency (50/60 Hz) Magnetic field IEC 61000-4-8 EN 61000-4-8: 2010	30 A/m	30 A/m	Power frequency magnetic fields should be at levels characteristic of a typical location in a typical commercial or hospital environment.
Note: Ut is the A.C. mains voltage prior to application of the test level.			

Table 13. Guidance and manufacturer's declaration - electromagnetic immunity for the Aerogen Solo nebulizer system that is not life supporting

This Aerogen Solo nebulizer system is intended for use in the electromagnetic environment specified below. The customer or the user of the Aerogen Solo nebulizer system should assure that it is used in such an environment.

Immunity Test	IEC 60601 Test Level	Compliance Level	Electromagnetic Environment - Guidance
Conducted RF IEC 61000-4-6 EN 61000-4-6: 2014	3 Vrms outside industrial, scientific and medical (ISM) and amateur radio bands. 6 Vrms in ISM and amateur radio bands 150 kHz to 80 MHz	10 Vrms 150 kHz to 80 MHz	Portable and mobile RF communications equipment should be used no closer to any part of the Aerogen Solo nebulizer system, including cables, than the recommended separation distance calculated from the equation applicable to the frequency of the transmitter. Recommended Separation Distance $d = [1.17] \sqrt{P}$

Table 13. Guidance and manufacturer's declaration - electromagnetic immunity for the Aerogen Solo nebulizer system that is not life supporting (Continued)

Immunity Test	IEC 60601 Test Level	Compliance Level	Electromagnetic Environment - Guidance
Radiated RF IEC 61000-4-3 EN 61000-4-3: 2010	10 V/m 80 MHz to 2.7 GHz 27 V/m, 18 Hz PM 385 MHz 28 V/m, 50 %18 Hz PM 450 MHz 9 V/m, 217 Hz PM 710 MHz 9 V/m, 217 Hz PM 745 MHz 9 V/m, 217 Hz PM 780 MHz 28V/m, 18 Hz PM 810 MHz 28 V/m, 18 Hz PM 870 MHz 28 V/m, 18 Hz PM 930 MHz 28V/m, 217 Hz PM 1720 MHz 28 V/m, 217 Hz PM 1845 MHz 28 V/m, 217 Hz PM 1970 MHz 27 V/m, 217 Hz PM 2450 MHz 9V/m, 217 Hz PM 5240 MHz	10 V/m 80 MHz to 2.7 GHz 27 V/m, 18 Hz PM 385 MHz 28 V/m, 50 %18 Hz PM 450 MHz 9 V/m, 217 Hz PM 710 MHz 9 V/m, 217 Hz PM 745 MHz 9 V/m, 217 Hz PM 780 MHz 9 V/m, 217 Hz PM 810 MHz 28V/m, 18 Hz PM 870 MHz 28 V/m, 18 Hz PM 930 MHz 28 V/m, 18 Hz PM 870 MHz 28 V/m, 18 Hz PM 930 MHz 28V/m, 217 Hz PM 1720 MHz 28 V/m, 18 Hz PM 1845 MHz 28V/m, 217 Hz PM 1970 MHz 27 V/m, 217 Hz PM 1720 MHz 28 V/m, 217 Hz PM 1845 MHz	d = [1.17] √P... 80MHz to 800MHz d = [2.33] √P... 800MHz to 2.5GHz where P is the maximum output power rating of the transmitter in Watts (W) according to the transmitter manufacturer and d is the recommended separation distance in meters (m). Field strengths from fixed RF transmitters, as determined by an electromagnetic site survey, ^a should be less than the compliance level in each frequency range. ^b Interference may occur in the vicinity of equipment marked with the following symbol: 

Table 13. Guidance and manufacturer's declaration - electromagnetic immunity for the Aerogen Solo nebulizer system that is not life supporting (Continued)

	9 V/m, 217 Hz PM 5500 MHz	28 V/m, 217 Hz PM 1970 MHz	
	9 V/m, 217 Hz PM 5785 MHz	27 V/m, 217 Hz PM 2450 MHz	
		9V/m, 217 Hz PM 5240 MHz	
		9 V/m, 217 Hz PM 5500 MHz	
		9 V/m, 217 Hz PM 5785 MHz	

Note 1: At 80 MHz and 800 MHz, the separation distance for the higher frequency range applies.

Note 2: These guidelines may not apply in all situations. Electromagnetic propagation is affected by absorption and reflection from structures, objects and people.

- a) Field strengths from fixed transmitters, such as base stations for radio (cellular/cordless) telephones and land mobile radios, amateur radio, AM and FM radio broadcast and TV broadcast cannot be predicted theoretically with accuracy. To assess the electromagnetic environment due to fixed RF transmitters, an electromagnetic site survey should be considered. If the measured field strength in the location in which the Aerogen Solo nebulizer system is used exceeds the applicable RF compliance level above, the Aerogen Solo nebulizer system should be observed to verify normal operation. If abnormal performance is observed, additional measures may be necessary, such as re-orientating or relocating the Aerogen Solo nebulizer system.
- b) Over the frequency range 150 kHz to 80 MHz, field strengths should be less than [V]V/m.

This page has been intentionally left blank

Aerogen[®]

Pioneering Aerosol Drug Delivery

US. +1 (866) 423-7643

e. info@aerogen.com

w. www.aerogen.com

© 2020 Aerogen Ltd.
Part No. AG-AS3050-US
P/N 30-674 Rev L

Rx Only



Manufacturer

Aerogen Ltd.
Galway Business Park,
Dangan, Galway,
Ireland.